

# Design Tips for Shower Enclosures



House of Glass  
424 N. York St.  
Elmhurst, IL 60126



Phone: 630.834.3031  
Fax: 630.834.2687  
info@houseofglasselmhurst.com

# Design Tip #1

## Frameless Heavy Glass Shower Enclosures REQUIRE Proper Studding In The Walls

The wall where a door will be hinged off of should have wood studs, or blocking, behind it. If metal studs were used during the original wall construction, wood studs should be added where the hinges will anchor.

NEVER run wires or pipes through or in front of studs where anchoring will be done. If you know wires or pipes have been installed this way, be sure to tell us right away, prior to installation. Take pictures! There is a lot going on with any remodel, pictures are a valuable resource.

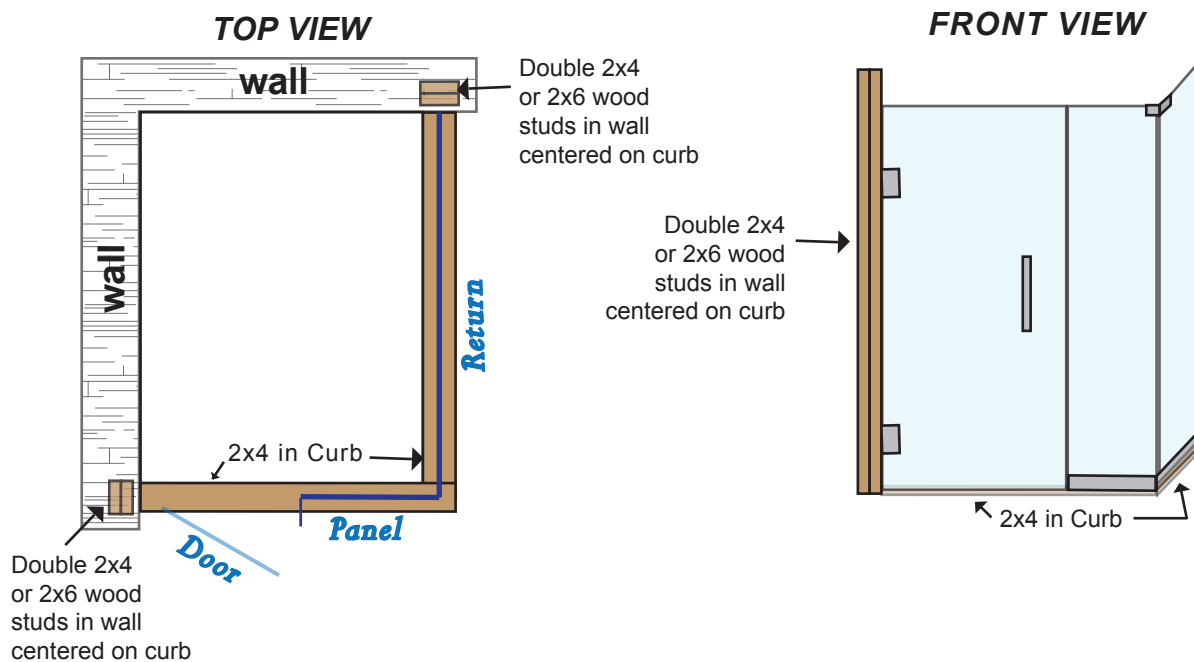

If a heavy glass shower enclosure is installed without proper studding, which is NOT RECOMMENDED, the door may sag, requiring adjustments; Or, worst case scenario, may pull out of the wall. Remember, a heavy glass shower door can weigh anywhere from 75-140lbs. It needs more than just drywall to hold on to. If you are unsure if there is studding in the wall, contact your contractor. There are ways to anchor a door in a wall without studding, but it will cost more.

House of Glass  
424 N. York St.  
Elmhurst, IL 60126



Phone: 630.834.3031  
Fax: 630.834.2687  
info@houseofglasselmhurst.com

## Design Tip #2

### Never design a curb (the sill under the door) on an angle

This applies to 135 degree standard angle enclosures, 90 degree enclosures, as well as custom angle enclosure openings.

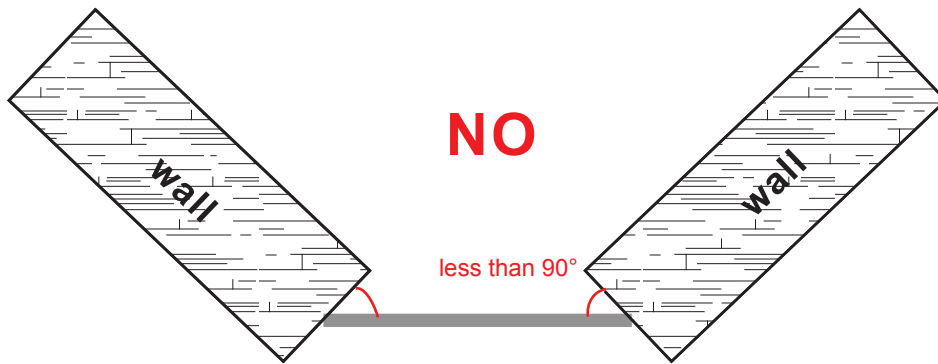

Always design a curb so the door can freely swing in and out. The only way to do this is by making the curb hit the return knee wall or angled sill at 90 degrees (square).

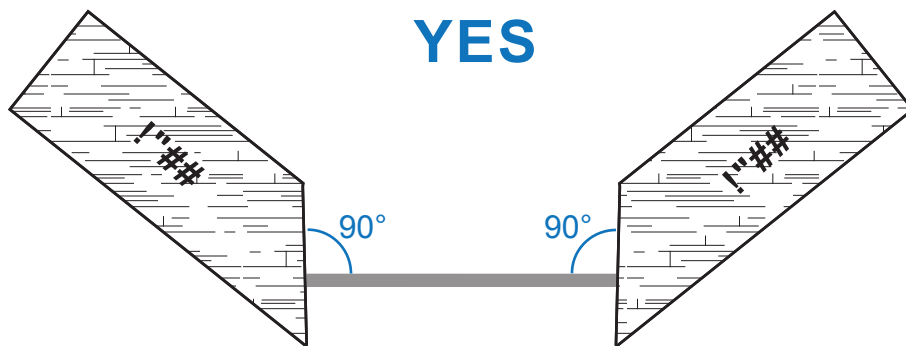

House of Glass  
424 N. York St.  
Elmhurst, IL 60126



Phone: 630.834.3031  
Fax: 630.834.2687  
info@houseofglasselmhurst.com

# Design Tip #3

## Always Try to Use Standard Angles in Your Design

Door, Panel & 90° Return

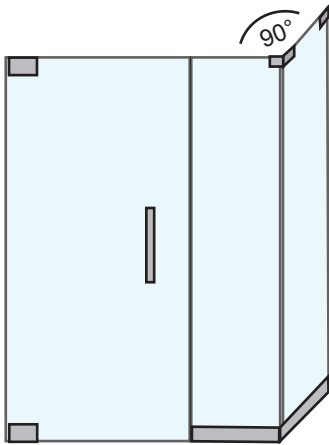

135° Neo Angle Shower

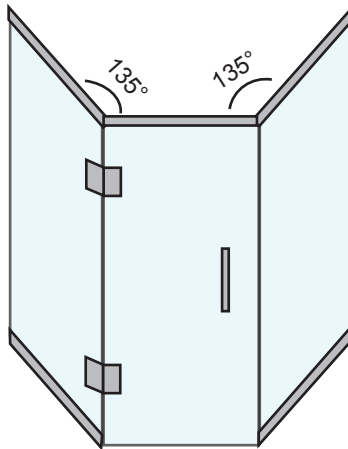

Door w/ 180° Inline Panel

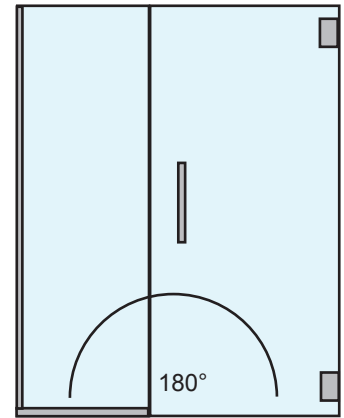

TOP VIEW

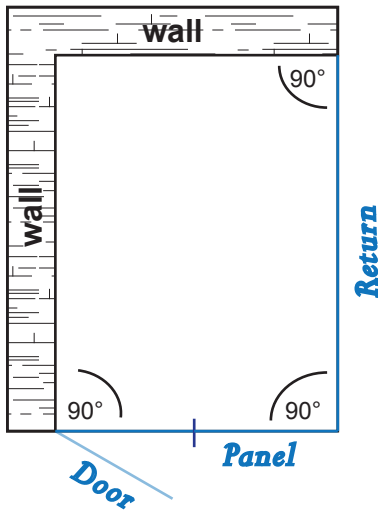

TOP VIEW

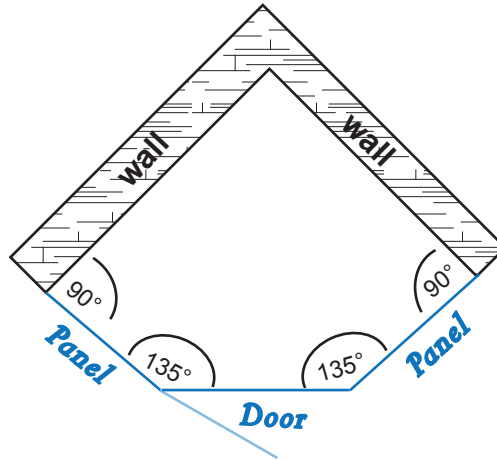

TOP VIEW

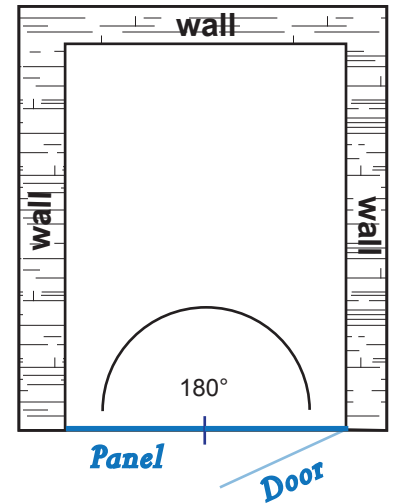

*Custom angles are possible, but come with custom pricing.  
Use standard angles (90°, 135° & 180°) to help keep the cost down.*

House of Glass  
424 N. York St.  
Elmhurst, IL 60126



Phone: 630.834.3031  
Fax: 630.834.2687  
info@houseofglasselmhurst.com

## Design Tip #4

### Do NOT Direct Body Sprays or Shower Heads at the Shower Door / Opening

All body sprays / shower heads should be directed towards the tiled wall or fixed panels.  
NEVER install body jets / sprays or shower heads directly opposite the shower door / opening.

**YES**

TOP VIEW

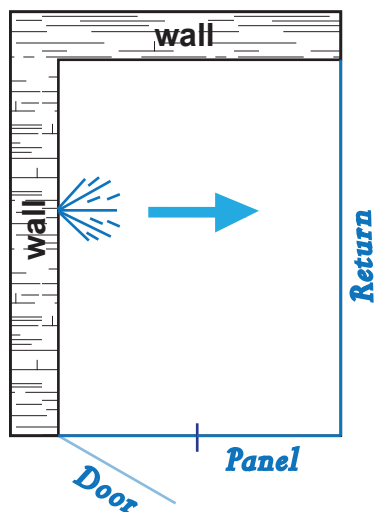

**YES**

TOP VIEW

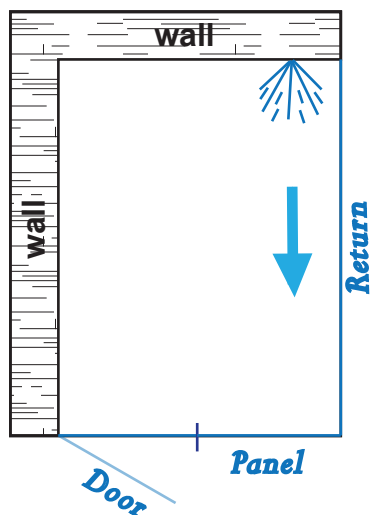

**NO**

TOP VIEW

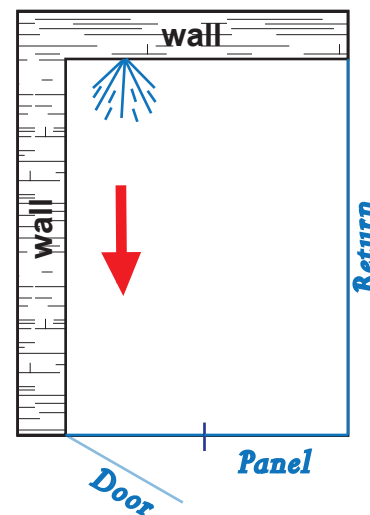

The most vulnerable area of any shower enclosure is the door / opening. Keep direct water spray from body jets and shower heads away to ensure less water from escaping.

House of Glass  
424 N. York St.  
Elmhurst, IL 60126



Phone: 630.834.3031  
Fax: 630.834.2687  
info@houseofglasselmhurst.com

## Design Tip #5

If Using a Raised Decorative Tile Border on the Wall,  
Be Sure It Does NOT Interfere with  
the Swing Area of the Door

YES

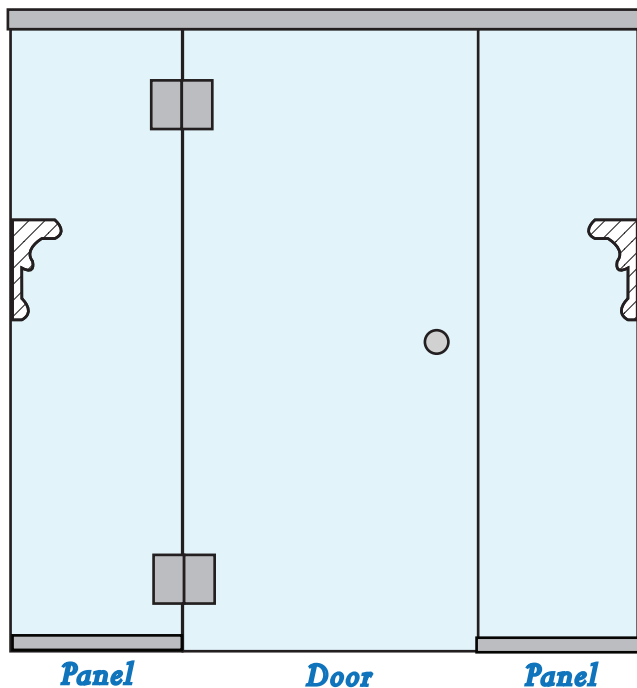

NO

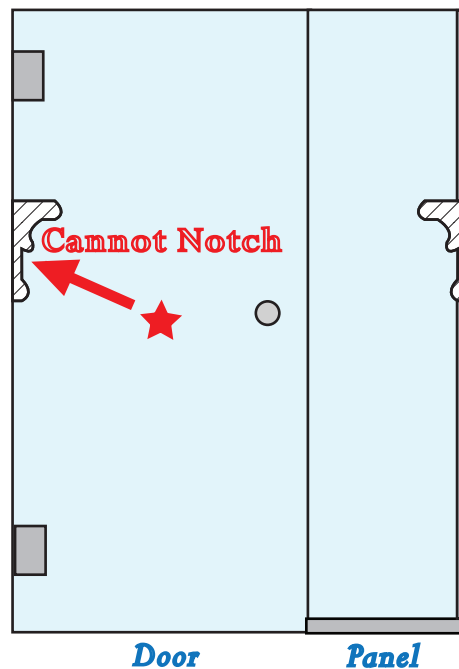

*Notching decorative tile in a door area **can** be done, but it is not always an aesthetically pleasing option.*



House of Glass  
424 N. York St.  
Elmhurst, IL 60126



Phone: 630.834.3031  
Fax: 630.834.2687  
info@houseofglasselmhurst.com

## Design Tip #6

### Be Cautious When Using Glass Tiles

Glass tiles *should only* be used as an accent. Your shower enclosure requires drilling of tiles.



If you have glass tiles, or plan on having them, try to avoid placing glass tiles in the areas where shower door hinges will be attached. ***Glass tile has a tendency to break when it is drilled!***

House of Glass  
424 N. York St.  
Elmhurst, IL 60126



Phone: 630.834.3031  
Fax: 630.834.2687  
info@houseofglasselmhurst.com

## Design Tip #7

**Do NOT Create Any Overhangs Near the Door Closing**

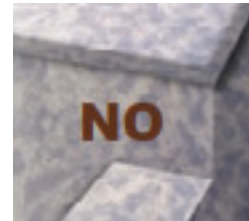
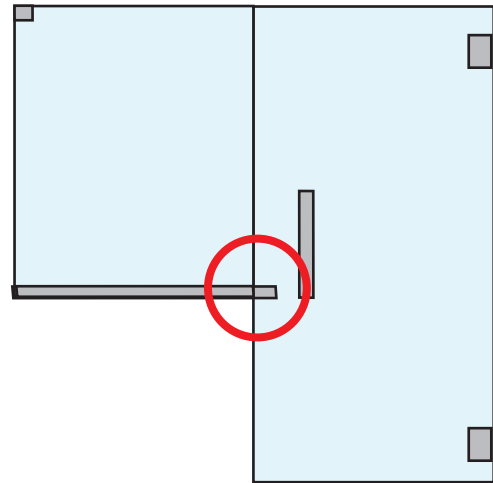
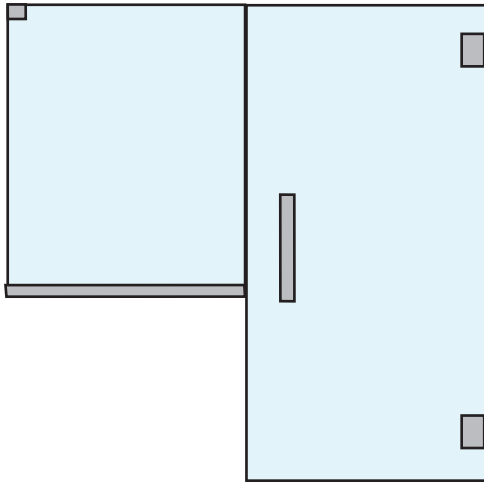

Overhangs create problem gaps that can cause serious leaking issues. It can also result in the need to notch your granite, marble, or tile. If your design includes a seat or has a knee wall, be sure the top sits flush with the sides.

House of Glass  
424 N. York St.  
Elmhurst, IL 60126



Phone: 630.834.3031  
Fax: 630.834.2687  
info@houseofglasselmhurst.com



## Design Tip #8

The Face of Any Knee Wall, or Seat Where the Shower Door Closes, Should Be Plumb

**YES**

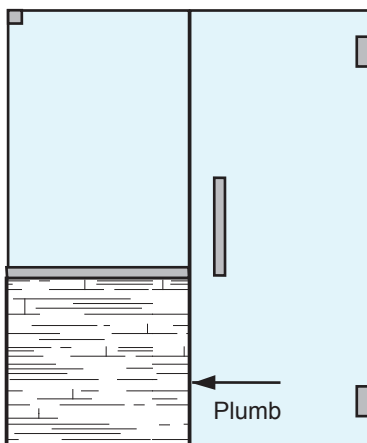

**NO**

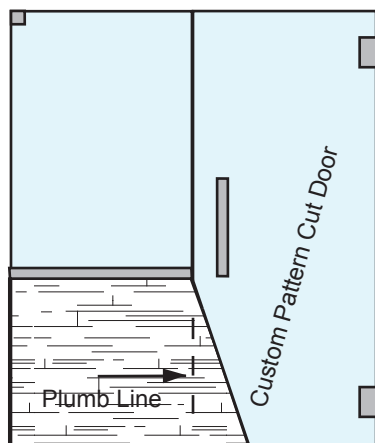

**NO**

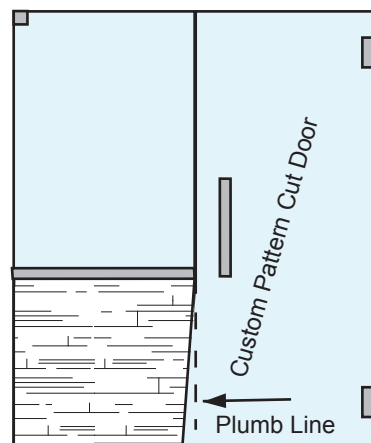

If knee wall or seat face is not plumb, you are either looking at a costly custom pattern cut door or a straight door with unsightly vinyl seals to fill the gap between the plumb line and the face of the knee wall or seat, so make sure the knee wall or seat is done correctly the first time.

House of Glass  
424 N. York St.  
Elmhurst, IL 60126



Phone: 630.834.3031  
Fax: 630.834.2687  
info@houseofglasselmhurst.com

# Design Tip #9

## Wall Problems

Ideally, the walls that meet the glass should be perfectly plumb.  
However, walls that are not perfectly plumb can still work.

**Perfectly Plumb**

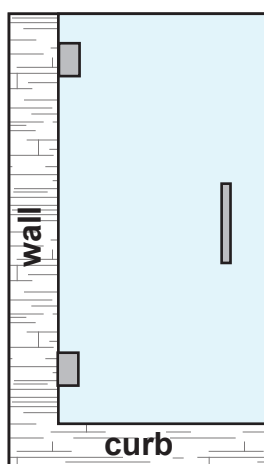

***Ideal***

Can use a standard door,  
if opening size is standard  
(most cost effective)

**Not Plumb**

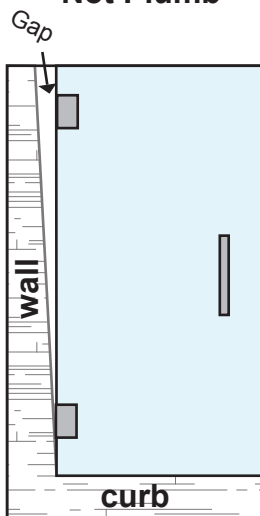

***Not Ideal***

Wall "out of square"  
at top or bottom

**Solution**

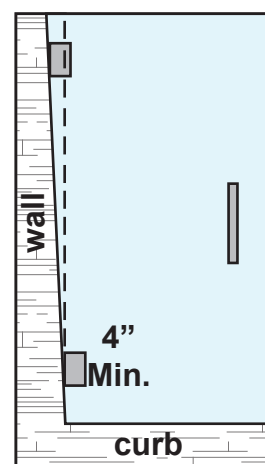

***Fix***

Custom Cut Door  
cut to match wall  
(little more expensive)

Walls that are "out of square", bellied, bowed, or just uneven can often times still accomodate a shower door. An onsite visit to check wall conditions is always best in these situations.

House of Glass  
424 N. York St.  
Elmhurst, IL 60126



Phone: 630.834.3031  
Fax: 630.834.2687  
info@houseofglasselmhurst.com

# Design Tip #10

## Be Careful Where You Place Towel Bars

**Problem #1:** Towel Bar on door hits the wall before door is fully opened

**Problem # 2:** Door hits Towel Bar on wall before opening 90°

**Problem #3:** Wall Mount or Pivot Hinge is even with the edge of the glass

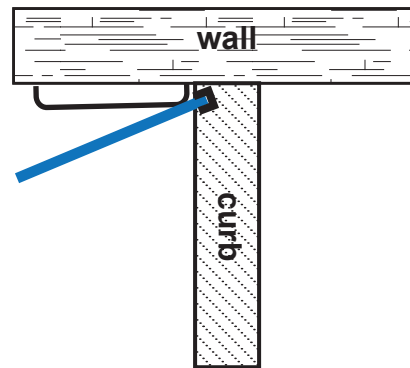
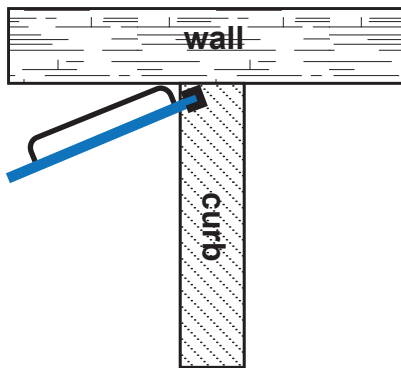

**Solution for all 3 problems:** Add a 4" minimum glass panel and use top & bottom Pivot Hinges. Glass panel and hinges need to be inset far enough from edge of glass / wall for door to clear towel bar.

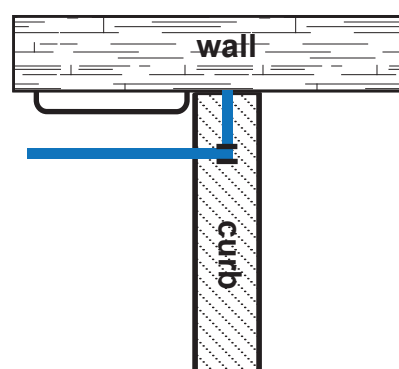
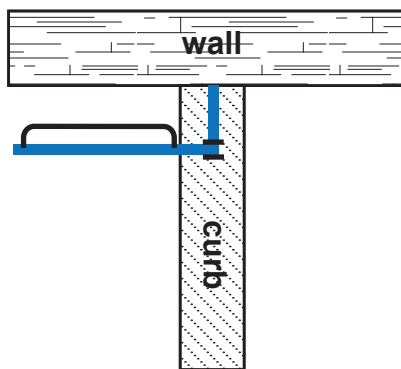

House of Glass  
424 N. York St.  
Elmhurst, IL 60126



Phone: 630.834.3031  
Fax: 630.834.2687  
info@houseofglasselmhurst.com

# Design Tip #11

## Very Tall Steam Showers May Require a Transom

Framed Doors over 80" tall, 3/8" Frameless Doors over 84", and 1/2" Frameless Doors over 96" REQUIRE a secondary piece of glass (transom) OR a soffit can be framed down to fill the gap. A transom can have pivot hinges added to be "operable" for ventilation when not sealing in steam.

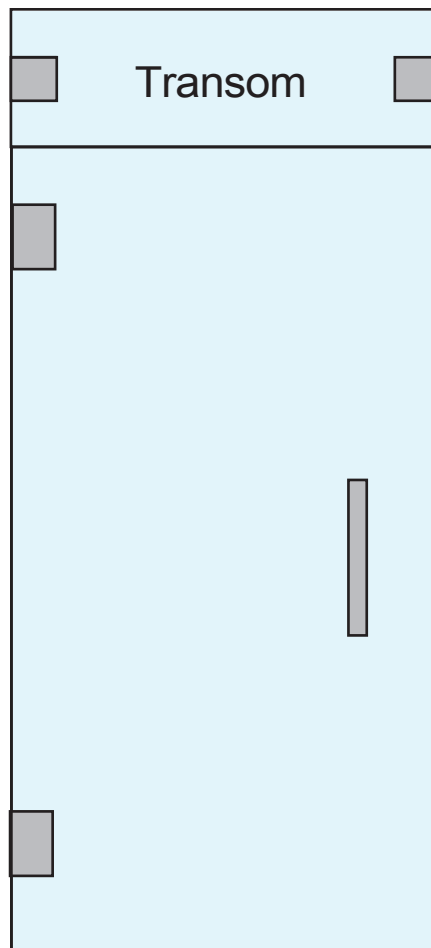

House of Glass  
424 N. York St.  
Elmhurst, IL 60126



Phone: 630.834.3031  
Fax: 630.834.2687  
info@houseofglasselmhurst.com

## Design Tip #12

**All Glass Panels Must Be a Minimum of 4" Wide**

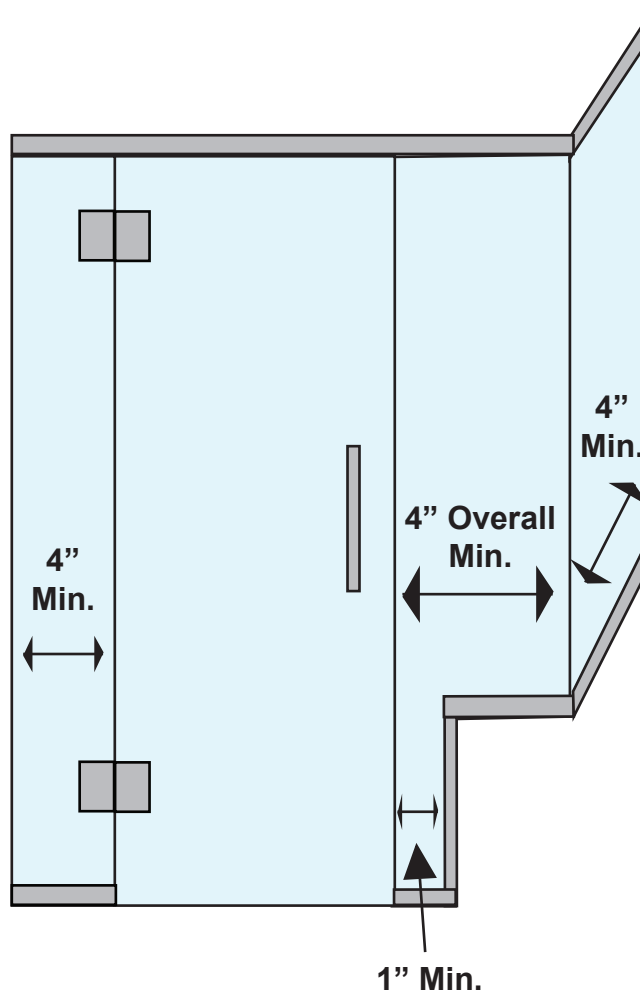

***Any glass used for shower enclosures MUST BE TEMPERED for safety.***

***Panels under 4" CANNOT be tempered.***

***Tempered glass CANNOT be cut once tempered.***

House of Glass  
424 N. York St.  
Elmhurst, IL 60126



Phone: 630.834.3031  
Fax: 630.834.2687  
info@houseofglasselmhurst.com

## Design Tip #13

### Soffit Must Be “Plumb” to Lower Curb

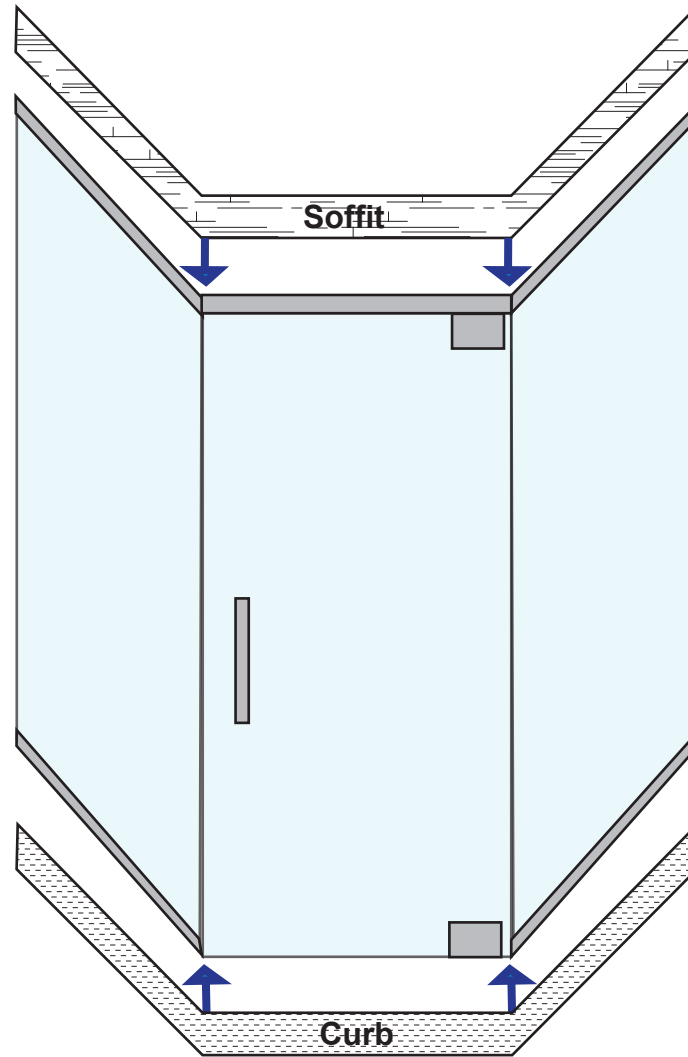

For best results, the soffit must be plumb, exactly matching the lower curb. If it doesn't line up exactly, your design will look "off".

House of Glass  
424 N. York St.  
Elmhurst, IL 60126



Phone: 630.834.3031  
Fax: 630.834.2687  
info@houseofglasselmhurst.com

## Design Tip #14

### Be Sure the Shower Design Allows for Proper Drainage

Always pitch shower floor pans, and the surface under the door and under all fixed panels, approx. 1/8" to 3/16" toward the interior of the shower. If the design includes a seat, that should also be pitched 1/8" to 3/16", towards the drain area. Too little pitch will result in water either pooling in an area, or if there's an outward pitch, water will leak back onto the bathroom floor. Too much inward pitch will result in premature wear of gaskets.

If tiling using marble or granite, always try to use one continuous piece to minimize grout joints under the door. Consult with a tile professional for more specifics.

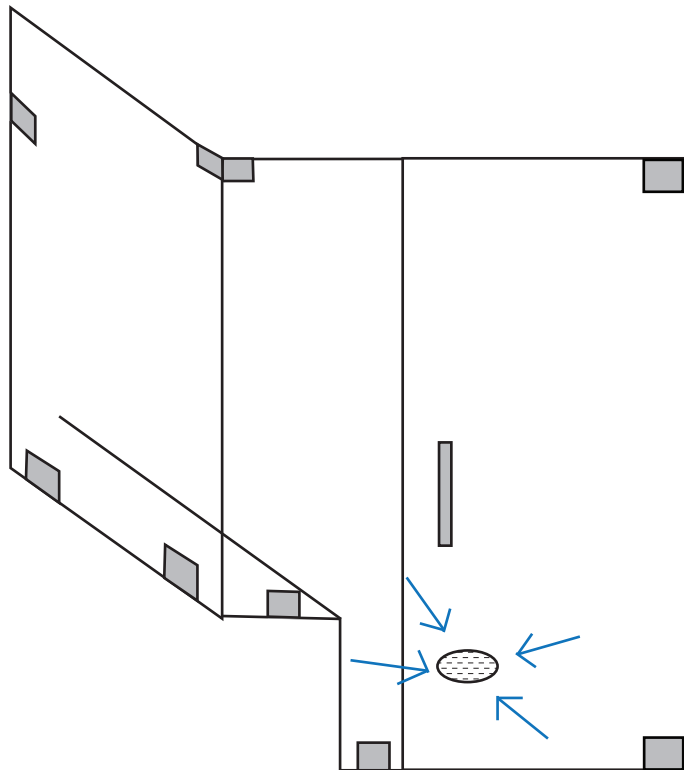

House of Glass  
424 N. York St.  
Elmhurst, IL 60126



Phone: 630.834.3031  
Fax: 630.834.2687  
info@houseofglasselmhurst.com

# Design Tip #15

## Form vs. Function - What is Frameless?

An appreciation of the features that distinguish frameless enclosures from “integrated” enclosures is essential. For one thing, the frameless shower can seldom be made completely “leak-proof”. Another challenge of the design is that almost every installation is a little different.

- Much of the allure of Heavy Glass Doors (3/8” or 1/2” glass) is the “solid feel”, which instantly conveys high quality. The word frameless is a misnomer as all doors have to have some amount of hardware and metal for structural support.
- Eliminating the header on multi-panel shower doors such as corner enclosures, door and inline panels, etc. can be done, but it is often at the expense of stability. Without header support, the fixed panels will have movement as the glass is only captured on the bottom and side by the u-channel hardware. This is a fact that is often overlooked when looking at magazine/online photos that are not necessarily functional.
- Eliminating Polycarbonate Seals (vinyls) can be done, but the tradeoff is a leaking shower door! If Polycarbonate Seals are eliminated and water hits the glass, it is guaranteed that the door will leak. Eliminating the vinyl seals is not an issue if the shower is so big that water will not hit the door.

House of Glass  
424 N. York St.  
Elmhurst, IL 60126



Phone: 630.834.3031  
Fax: 630.834.2687  
info@houseofglasselmhurst.com